



How to play: Hang the hoop on the wall, and have fun playing with the ball.

Instructions **Pattern:** 7 sheets **Number of Parts:** 10

You will need: Scissors, glue, a ruler, a used ball-point pen
Assembly tip: Trace along the folds with a ruler and a used pen(no-ink) to get a sharper, easier fold.

----- Mountain fold - - - - - Valley fold □ Glue spot
 _____ Scissors line ———— Cut in line

Caution: Glue, scissors and other tools may be dangerous to young children so be sure to keep them out of the reach of young children.

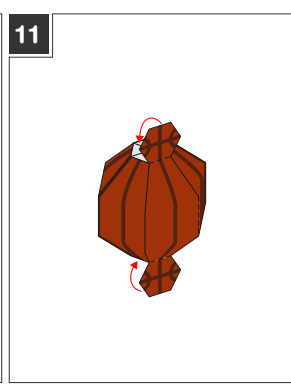
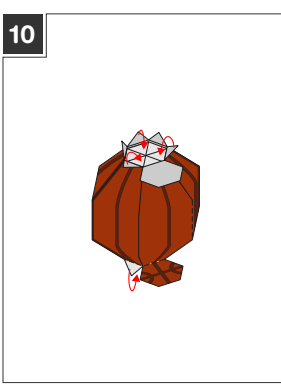
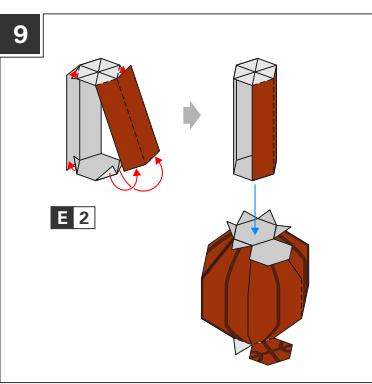
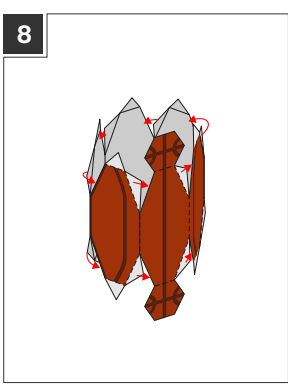
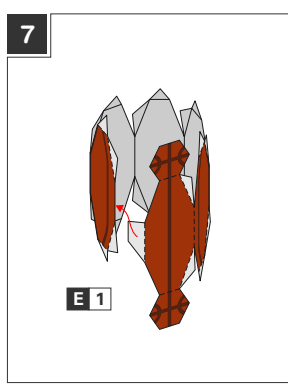
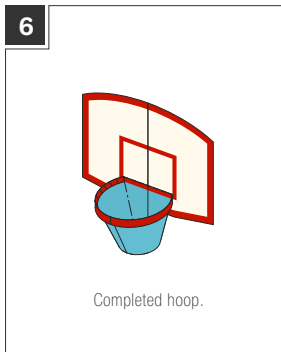
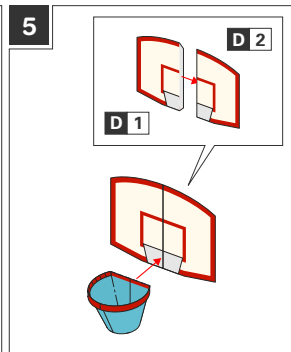
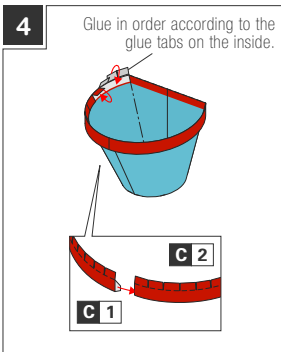
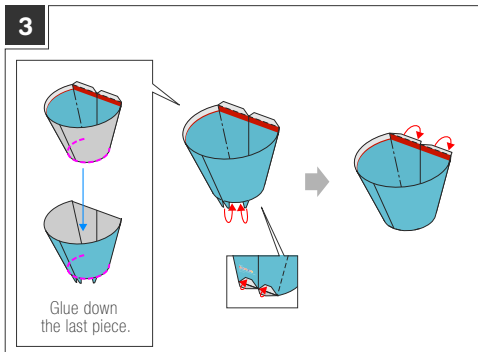
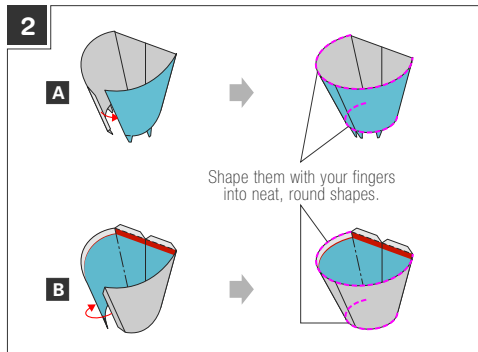
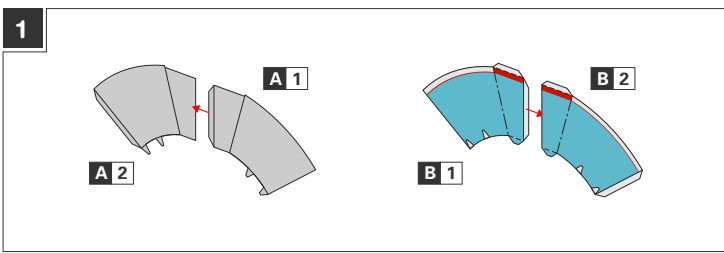

A 1

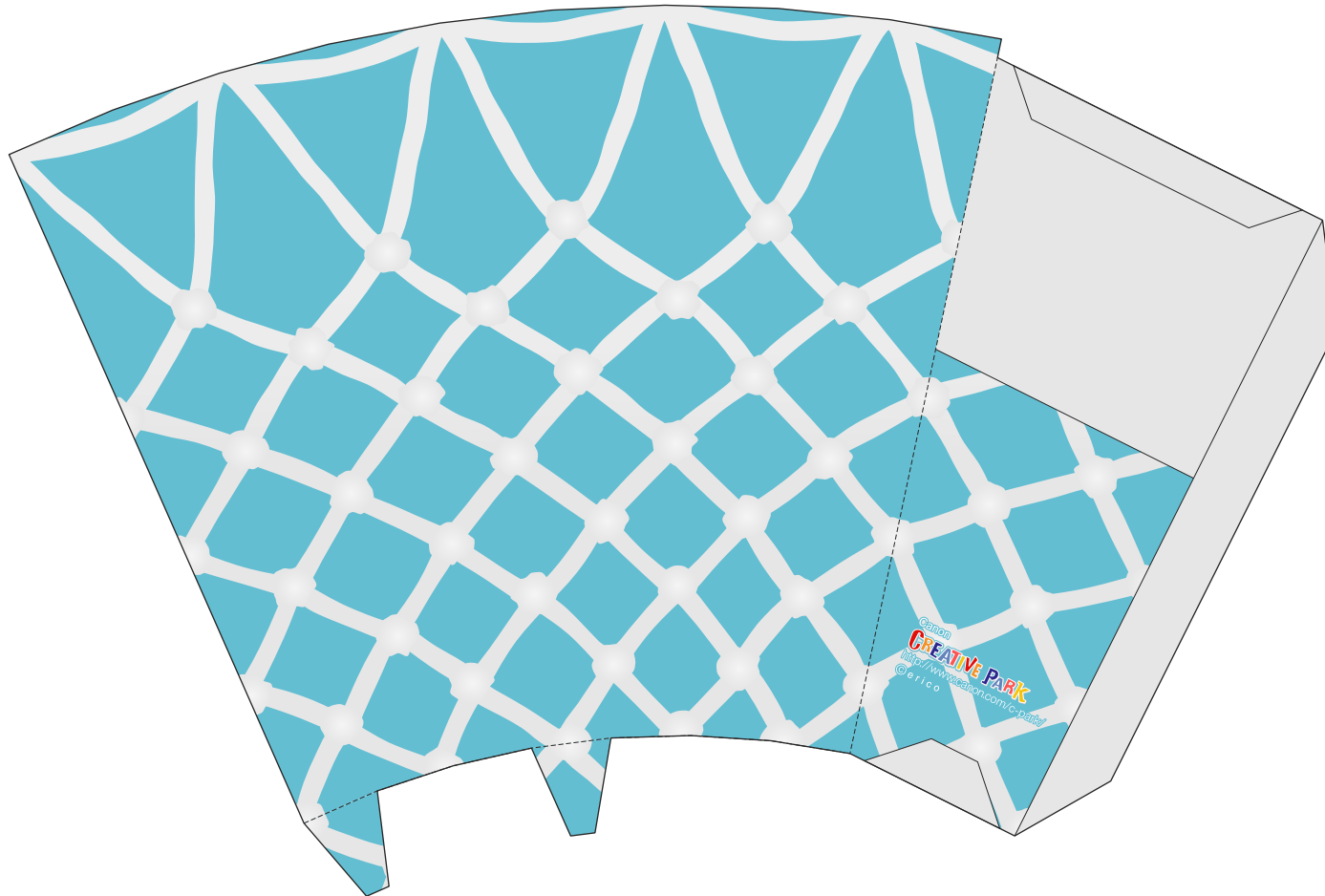

A 2

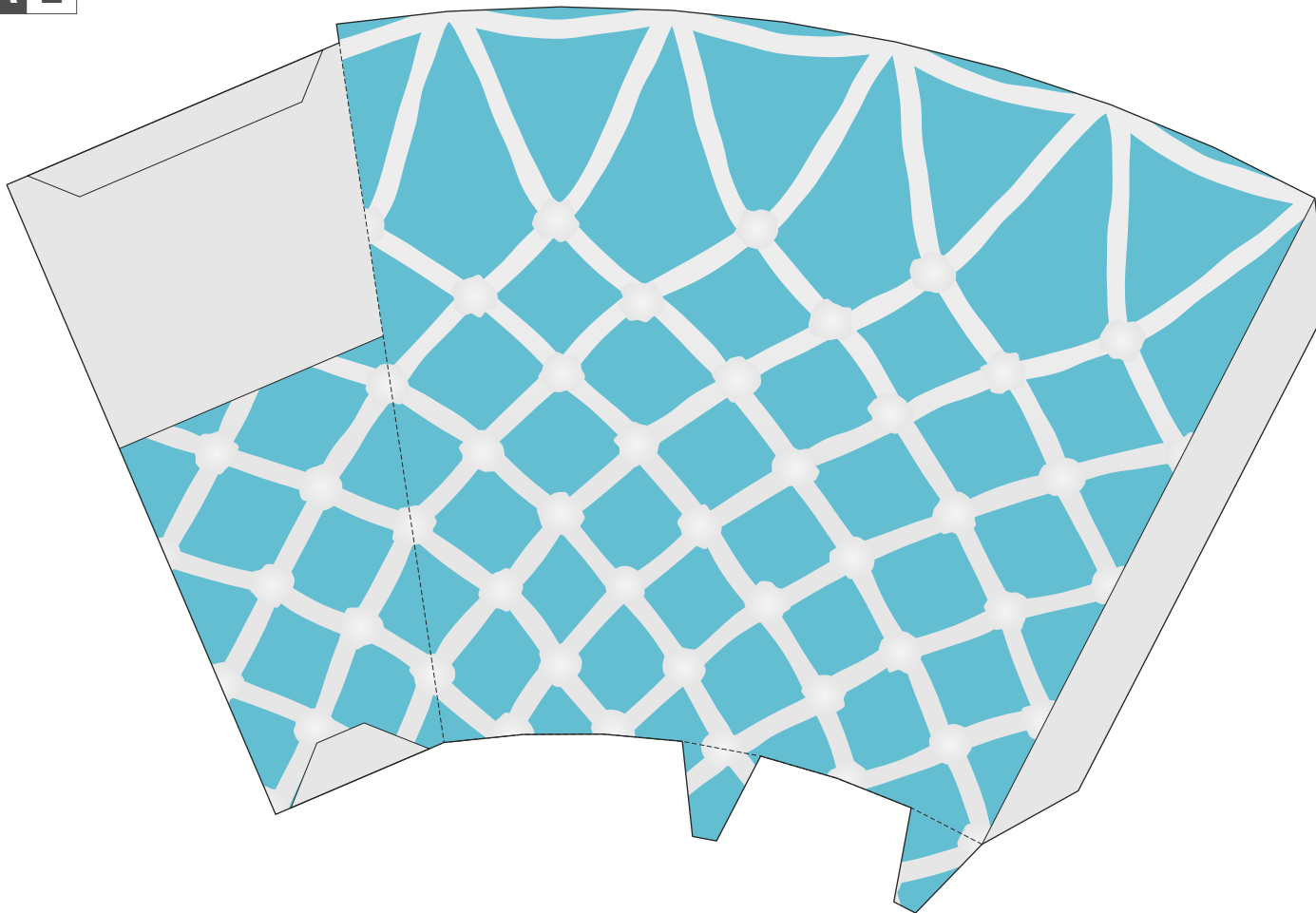

B 1

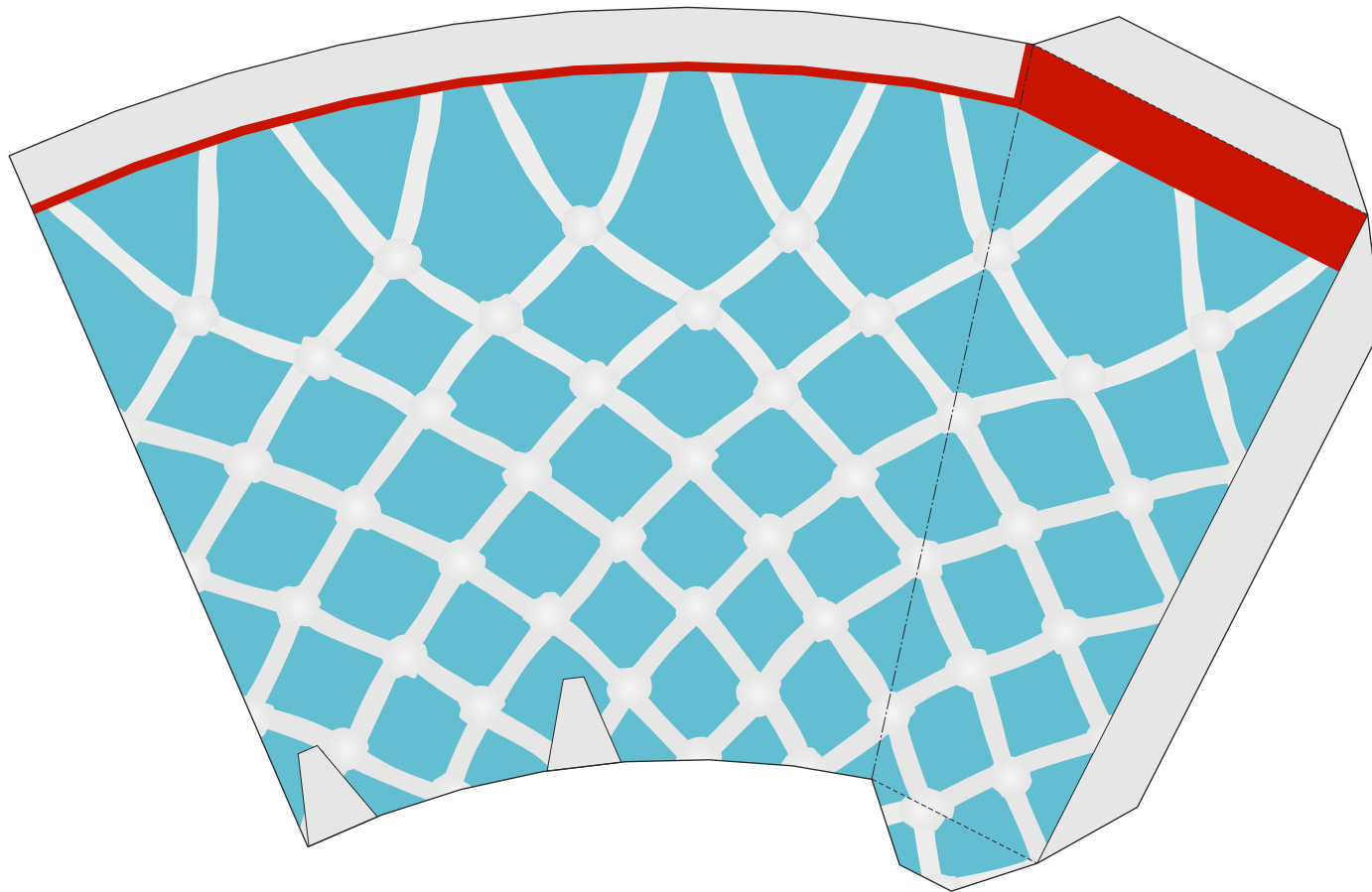

B 2

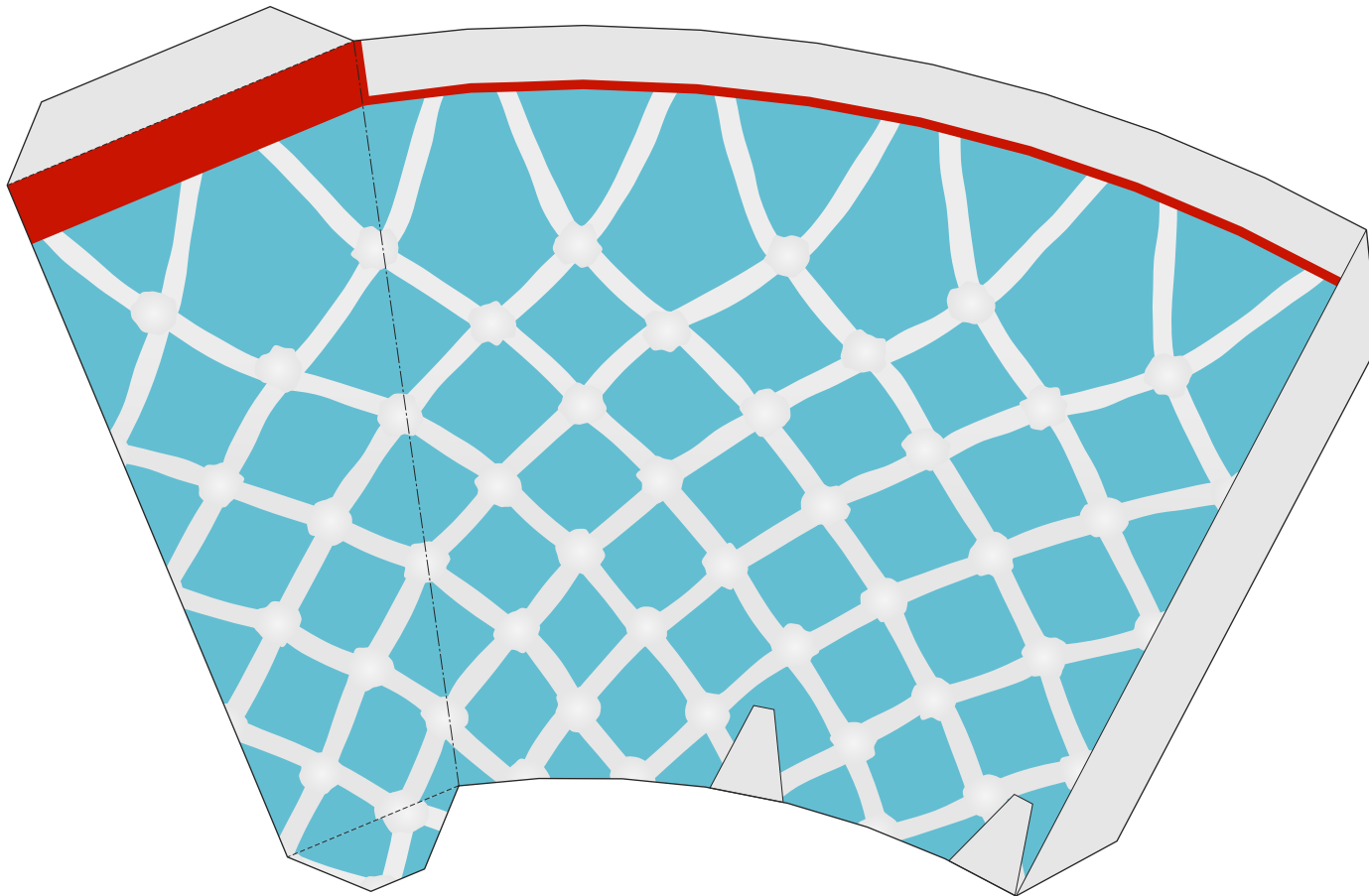

D 1

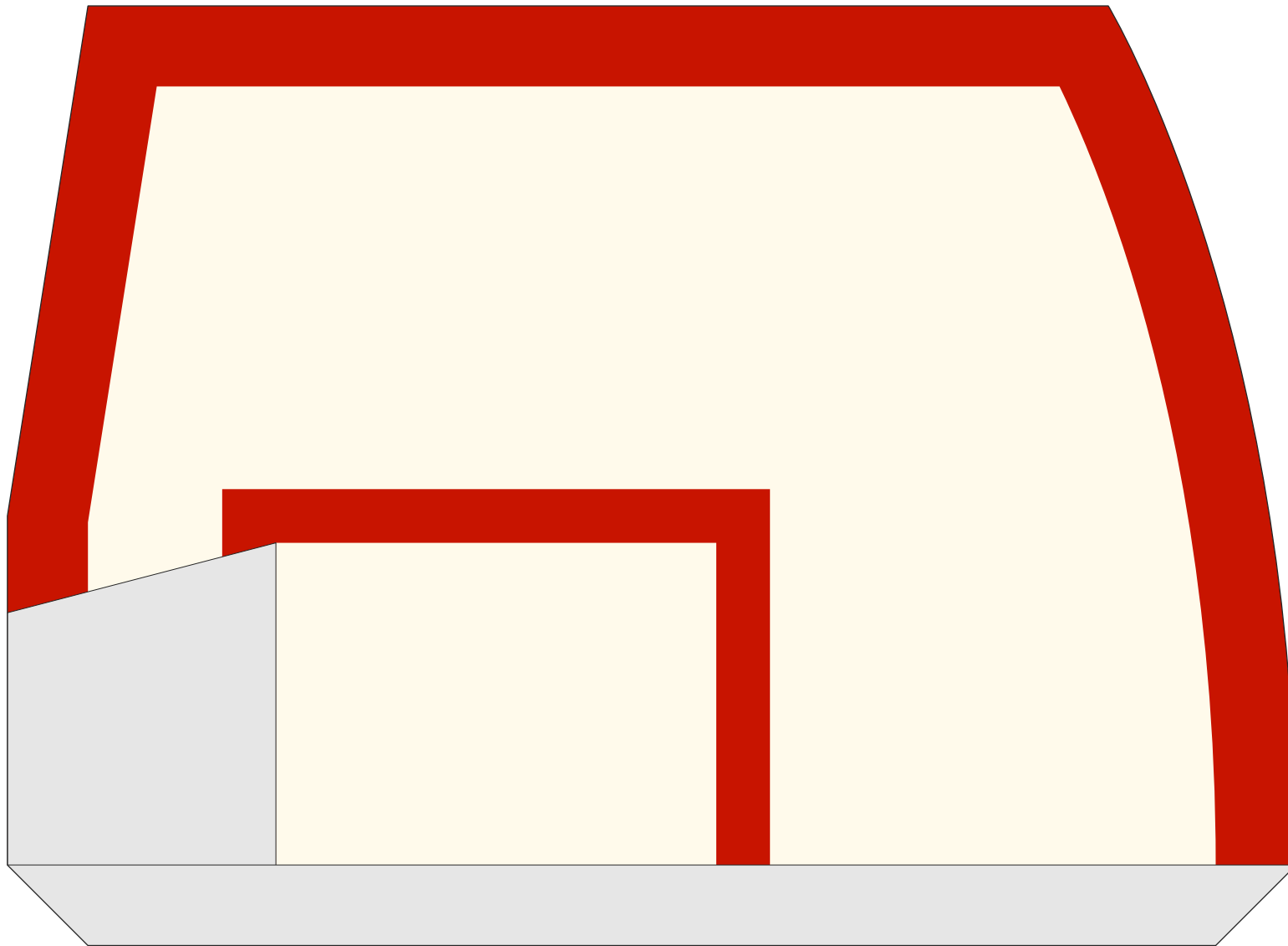

D 2

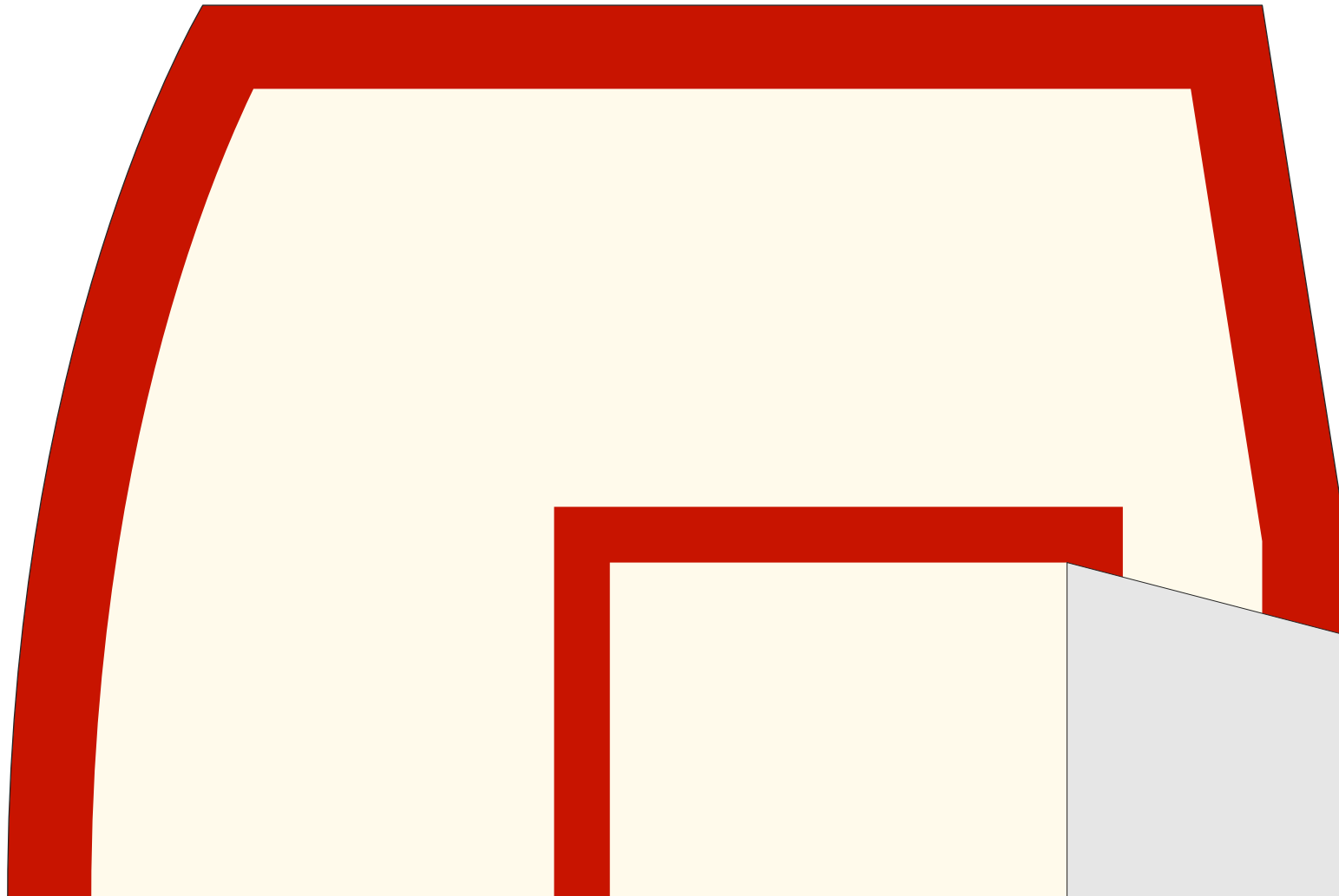

C 1

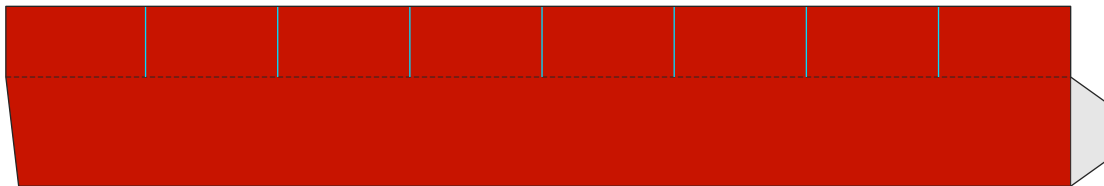

C 2

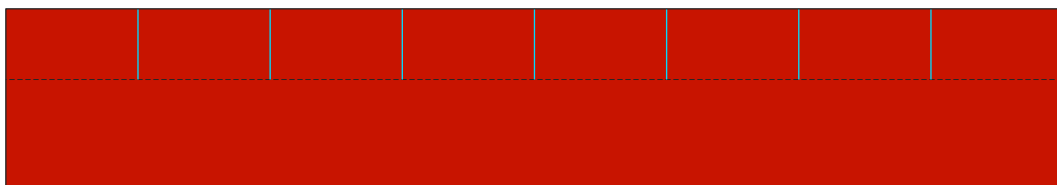

E 1

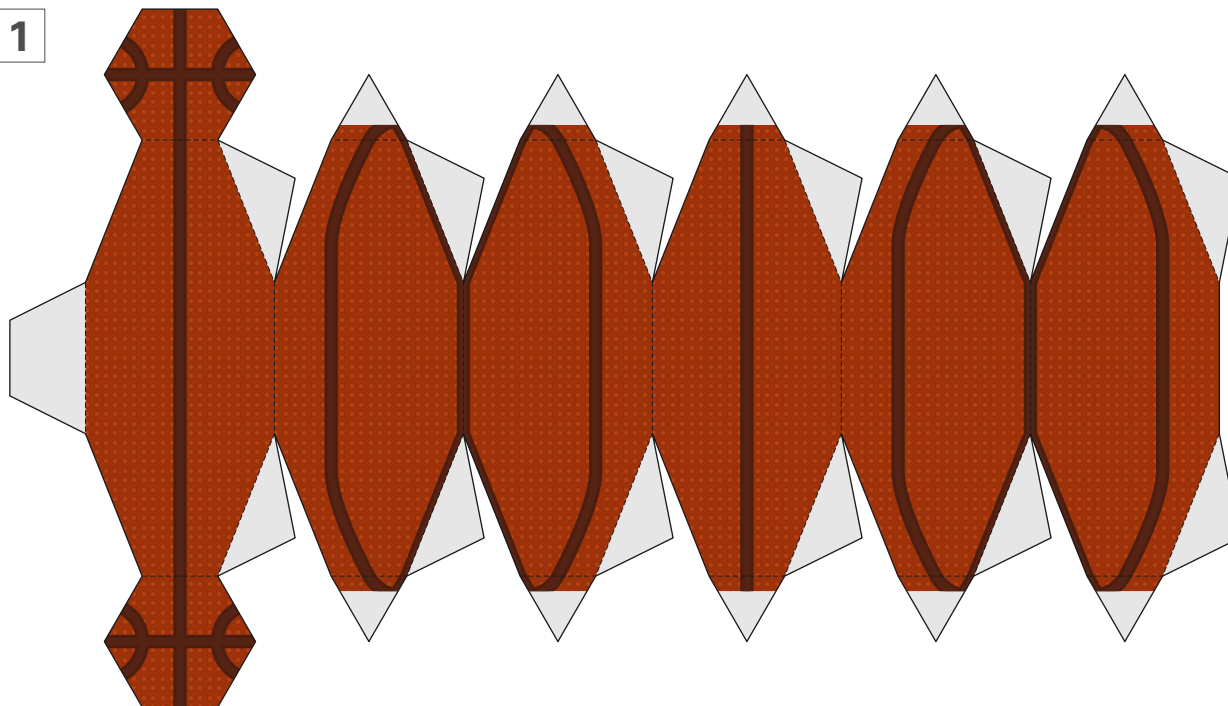

E 2

